

6 1 5 1 4 3 1 2 1 1

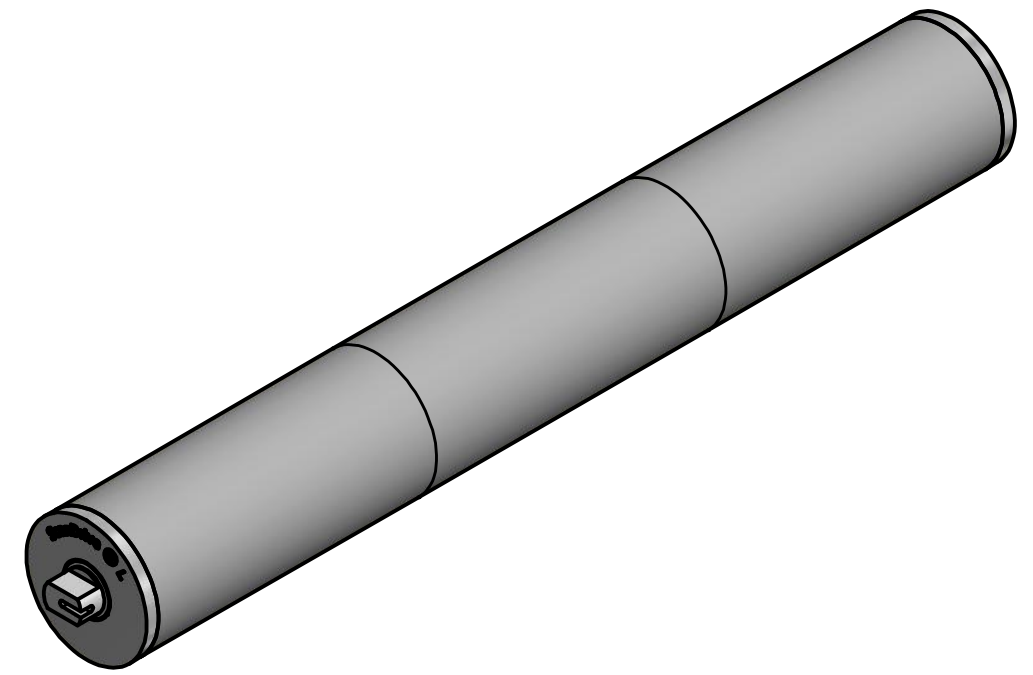
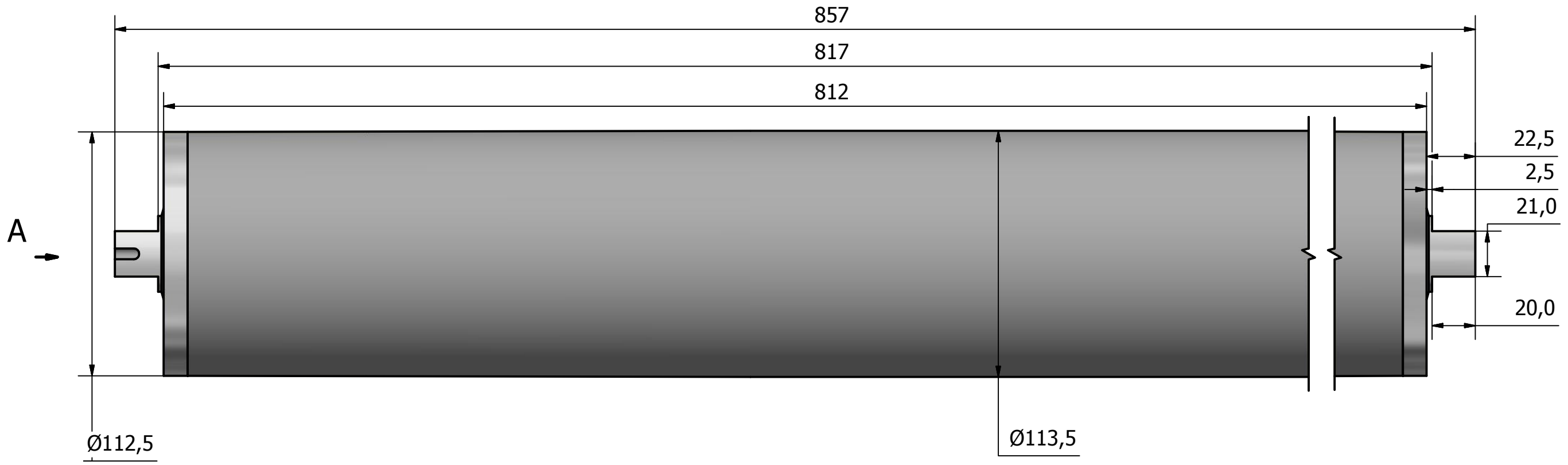

Designed by GUH	Checked by	Approved by	Date 13-06-2017	Date	Design state:	
Tolerance : acc. to DS/ISO 2768 - medium						
				Description:		Scale: 1:2
				Part number: Scandrive L Ø113 RL812		Sheet 1 / 1

6 1 5 1 4 3 1 2 1 1